

megaSun[®]

by KBL

Tower pureEnergy T230W and T200



Operation, Maintenance, Assembly

Copyright and trademark

Printed in Germany

© Copyright 2004 KBL-Solarien AG;

The scope of this documentation is limited to products by KBL-Solarien AG. This documentation must not be duplicated, photocopied, reproduced, translated or stored without the prior written permission of KBL-Solarien AG. It must not be copied on any electronic medium or stored in a retrieval system, neither in whole nor in part.



is a registered trademark of KBL-Solarien AG.

Certified according to DIN ISO 14001

**Only original spare parts - particularly tubes and burners
- may be used for replacement. Otherwise, both operating
licence and warranty clause become void.**



KBL-Solarien AG ·

Ringstraße 24-26 · 56307 Dernbach · Germany

Telephone +49(0)2689.9426-0 · Fax +49(0)2689.9426-66

eMail megaSun@kbl.de · Internet: www.megaSun.de

Table of Contents

1. Safety information	4
2. Maintenance plan	5
3. Optional features	6
4. Operation during the tanning session	6
4.1 Operating panel and display	7
4.2 Functions	9
4.3 Hints for studio operators	12
5. Maintenance of the unit	13
5.1 Cleaning and care	13
5.2 Removing and installing the acrylic panes	13
5.3 Tubes	14
5.4 Cooling and exhaust air	15
5.5 Audio system with mp3-sound-box.....	16
5.6 Replacing the aquaCool nozzles	16
6. Technical data	17
6.1 General data on T230W pureEnergy tanning unit	17
6.2 Views of the unit	18
7. Wiring diagrams	19
7.1 Mains voltage	19
7.2 <i>megaVoice</i> and music	20
7.3 External timer	21
8. Service	22
8.1 General information and structure	22
8.2 Service level I	23
8.3 Service level II	28
8.4 Replacing the <i>aquaCool</i> tank	31
8.5 Colour codes used for the water hoses	31
8.6 Error messages	32
9. Tanning instructions	33
9.1 General tanning instructions.....	33
9.2 megaSun T230W	34
9.3 megaSun T200	35
10. Assembly	35
10.1 Mounting of the Tower	36
10.2 Assembling of the Central Exhaust Air	38
11. Index	43

1. Safety information

Please observe the following safety information:

Tanning times Never exceed the tanning times.
Section 9.2 ff.

Timer **The tanning units may only be operated by a safety timer that complies with any applicable standards.**

Disconnecting Disconnect the fuses before opening the unit so that it is isolated from the mains supply!



Technical parameters The data given in the tanning schedules is based on the precondition that the tubes are replaced at regular intervals. (section 5.3)
Therefore, keep in mind resetting both the control (with CPI-equipped units, section 8.2) and the operating hours counter of the tubes (section 8.2).

Maintenance Also observe the maintenance intervals indicated in the maintenance plan (section 2).

Cleaning Never employ any cleaning agents other than *megaClean* products approved by KBL-Solarien AG, diluted in water at a ratio of 1:13 (section 5.1).

Protective net/cap for long hair For safety reasons, studio guests with long hair must wear a hair net or protective cap.



Close the door! **The door of the tower must be closed during and after the tanning session (backlash of the fan)!**

2. Maintenance plan

Maintenance intervals Regular maintenance work is required to ensure the safe operation of the tanning units. This must be documented accordingly. Cleaning works have to be carried out as soon as necessary; they are not included in this plan.

Operating hours	What needs to be done?
500-600	For inductive units: <ul style="list-style-type: none"> • Replace tubes. • Replace starters. • Reset hours counter to zero.
1000	For CPI-equipped units with megaSun CPI tubes in power mode: <ul style="list-style-type: none"> • Replace tubes. • Carry out reset. • Reset hours counter to zero.
	Replace aquaCool nozzles.
1200	For CPI-equipped units with megaSun CPI tubes in ECO mode: <ul style="list-style-type: none"> • Replace tubes. • Carry out reset. • Reset hours counter to zero.

3. Optional features

Feature	Explanation
aquaCool	Atomised water for refreshment
megaVoice	Acoustic user guide
Music, MP3 player	With 256 MB of storage capacity for music
Audio system	Amplifier and audio switch
Channel selection	For external music supply
CPI	Electronic ballasts and tube control

4. Operation during the tanning session

Note As the T230 is operated with electronic starter: After having switched off the tubes wait at least one minute before switching on again. Otherwise the electronic starters may be damaged.

General After switching on the control voltage, the following information is displayed for 2 seconds each. Afterwards, a running text appears:

Firmware version of the display

Display 13

Version of the control software

KBL4 TW 2.0

Type of tanning unit

T230

Type of tubes

XXL SUPER P.



Running text

The start of the tanning program depends on the kind of studio control. If a simple coin-operated system has been installed, the tanning program is started by inserting coins or tokens. After the warm-up time has elapsed, the tanning lamps are switched on automatically.

If the "Start" button is pressed during this warm-up time, the lamps are switched on immediately.

A number of basic settings, e.g. coloured-light stimulation, aroma therapy, timing functions, etc., are made on the service level I.

4.1 Operating panel and display

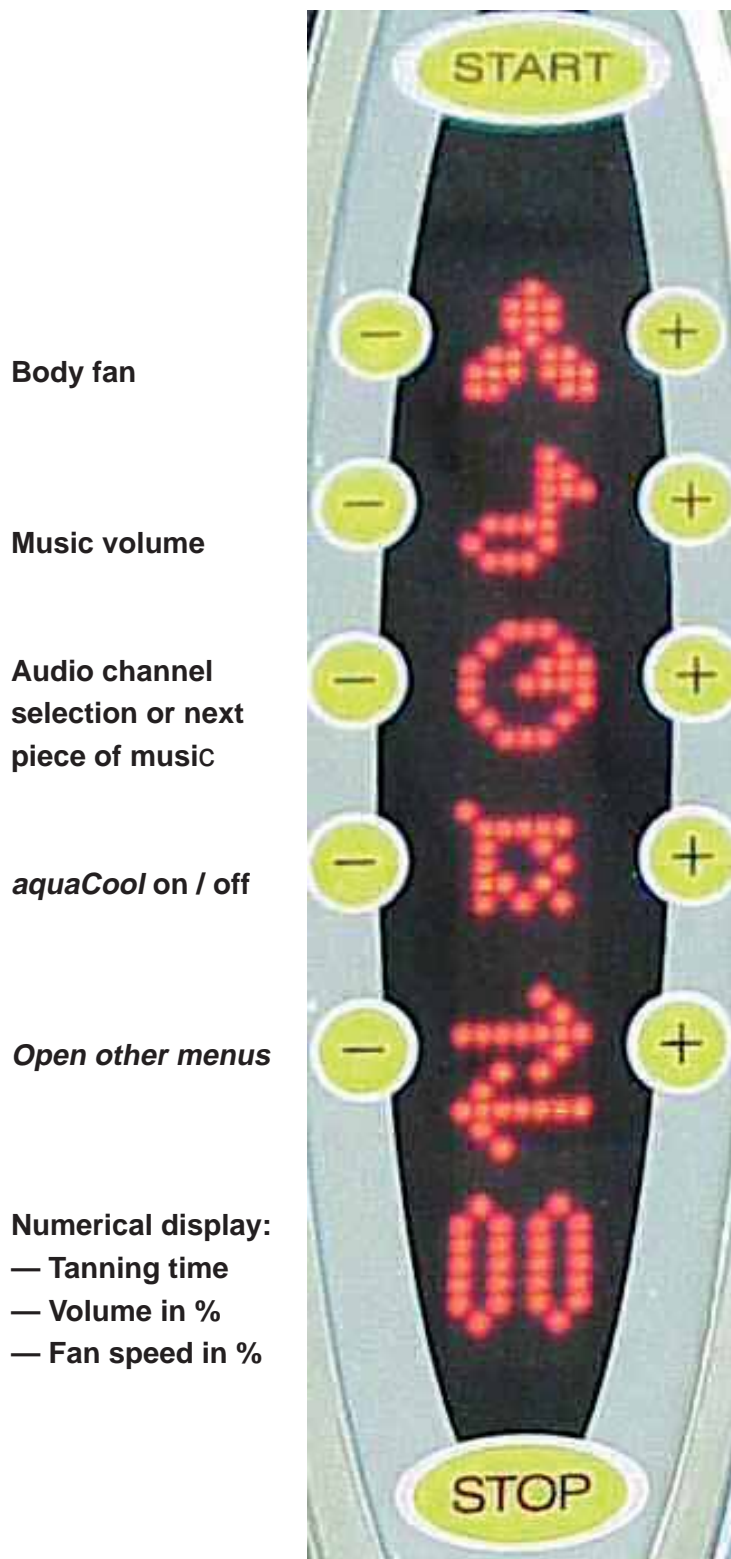

The running text is displayed as long as the tanning unit is in „standby position“. As soon as the corresponding signal comes in from the coin-box system, the available functions are displayed. You can now operate the tanning system by pressing the corresponding buttons.

By pressing the plus button, you can switch on a function or increase the power level step by step. To set the maximum value (e.g. fan speed), the button must be pressed repeatedly until the maximum value is reached.

The minus button is used to switch off a function, or to decrease the power level step by step. To set the minimum value (e.g. volume), the button must be pressed repeatedly until the desired value is reached.

By pressing START, the unit can be switched on during the warm-up time.

If the tanning session has been interrupted by pressing the STOP button, it may be continued by touching the START button again, provided

that the total run time controlled by the coin-box system has not elapsed yet. You can end the tanning session prematurely by pressing the STOP button for at least 2 seconds.

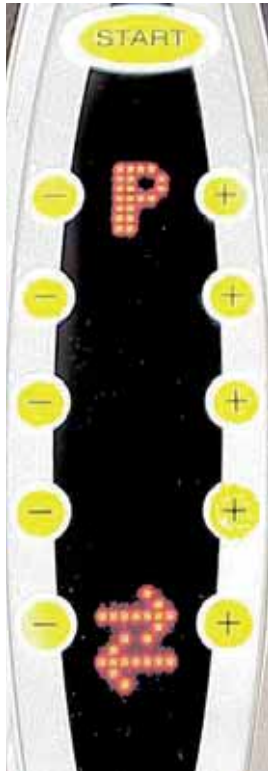

If you press the key “+” or “-” close to the double arrow in the main menu the next or the previous menu occurs.

“P” means program of the music: Wellness, Pop, or Studio (external music).

If you press the key “+” or “-” close to the “P” the next possible music source (here POP) is displayed momentary.

So you are able to select different music programs: Wellness, Pop or Studio (external music source) if they are present and configured.

The next titel oder music channel is selected in the main menu.

More about the music options see Service level I.

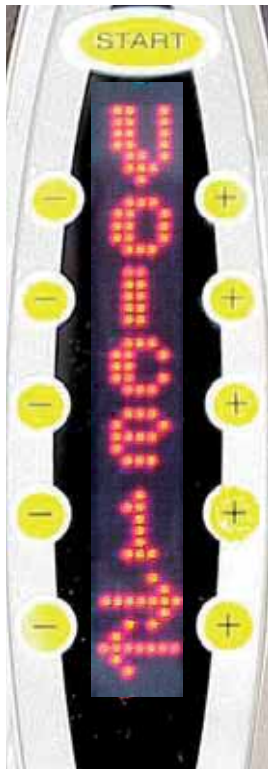
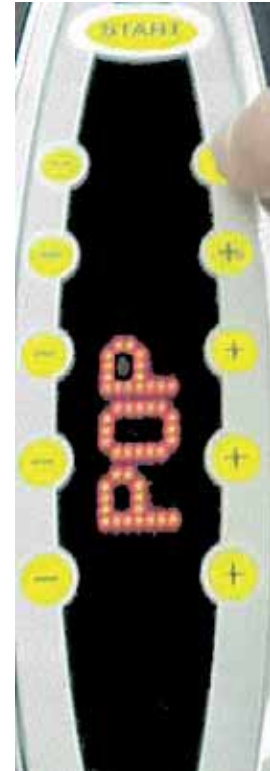

The menu “Voice”:

The option megaVoice may be switched off or on by the client during the tanning session.

To do this press the keys “+” or “-” at the right or left of the “1” or “0” under the word “Voice”.

Start



Use the START button to turn the unit on during the warm-up time.

If the tanning session has been interrupted by pressing the STOP button, it may be continued after pressing START again, provided that the total run time has not elapsed yet.

The numeric display shows the tanning time.

After the total tanning time has elapsed, the running text is displayed.

Stop



You can end the tanning session prematurely by pressing the STOP button for at least 2 seconds.

Both buttons mentioned above are also used within the service menus for navigation and saving of values.

4.2 Functions

Body fan

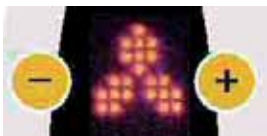

The power of the body fan can be increased or reduced in steps of 10% by touching the “+” or “-“ button.

After turning the unit on, the initial value is set to 30%. Every minuit this value is increased by 10 % up to the maximum value of 99%.

In the case of any changes, the current setting is displayed as a two-digit number between “60“ (minimum) and “99“ (maximum) in the numeric field for a short time. This is also the control range of the body fan changed by the tanning client.

The body fan cannot be switched off durin the tanning session. After the tanning session the body fan goes for 3 minuits to 20% before it is switched off.

Volume



You can adjust the volume of the music using the “+“ and “-“ fields. When adjusting the volume, the current setting is displayed in the numeric field as a value between 0 and 99%.

Press the respective button several times until the desired volume is reached.

Channel selection



Here you can choose the audio source, e.g. change the CD or go to the next piece of music (MP3) in case of Wellness or Pop. The MP3 player is equipped with a 256 MB chip. The first 10 tracks are Wellness music and the rest is Pop music. The studio



operator can select the kind of music himself/herself and then transfer it to the chip via a personal computer.

The MP3 player is designed in such a way that only the chip containing the music has to be exchanged.

Optionally, during the tanning breaks, the music of the MP3 player can be switched on.

The switching over from default to studio music is done by pressing the “+” or “-“ buttons at the right-hand and left-hand side of the symbol.

As to channel selection (for external music), switching over to BCD selection is possible (see AUDIO menu on service level I).

aquaCool



The water-atomisation function can be switched off by pressing the “—“ button. In this case, the symbol is not animated any more. By pressing the “+“ button, aquaCool can be switched on again, and the symbol is animated.



Setting on system start: off



If the store of water is depleted, the animated symbol shown on the left-hand side is displayed.

megaVoice

megaVoice is an acoustic function that guides the studio guest quickly and easily through the operating options of the solarium. If desired, the studio customer can switch off *megaVoice* during the tanning session.

The “voice“ function can be switched on by pressing the “+“ buttons and switched off by touching the “-“ buttons (6...0).

The display flashes while the function is deactivated.

Run time

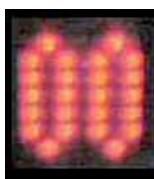

While the tanning program is running, the current run time is indicated in this field.

If the volume of the audio system is adjusted, the value set - between 0 and 99% - is displayed here for a short period of time.

The same applies for the setting of the fan speed: The value set - between 60 and 99% - is displayed in this field for a short time.

**Terminating the
tanning session**

After the tanning time has elapsed, a program is started to shut down the tanning unit:

- A voice (in the case of audio response) announces the end of the tanning session and says good-bye to the customer.
- Both tubes and fan are shut down in stages.

4.3 Hints for studio operators

Lighting after use (decorative lighting)

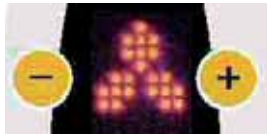

The unit lighting at the door can be switched off by pressing the “—” “+” “—” buttons. They are located on the right-hand/left-hand side of the fan symbol.

In addition, the service menu provides the option to program two turn-on/turn-off times - independent of each other - for each day of the week: AON - AOFF and BON - BOFF.
(see “Timer“ service menu)

Door lighting

An energy-saving lamp mounted in the door provides a decorative lighting of the unit.

Step	Procedure	Reference
1	Dismantle the acrylic pane of the door	see section 5.2
2	Remove the tubes from the centre part of the door.	
3	Undo the lamp holding plate (4 screws).	
4	Replace the lamp.	
5	Reassemble everything in reverse order.	

Internal lighting

There is a maintenance-free high-performance LED at the top inside the tower. As to disassembly, please refer to the photo. It can be accessed at the top from the outside.



5. Maintenance of the unit

5.1 Cleaning and care

Note	Do not use any cleaning agents other than those tested and approved by the manufacturer of the solarium.
Acrylic panes Handholds Door handles	To clean the acrylic panes, use <i>megaClean</i> , diluted in water at a ratio of 1:13. <i>megaClean</i> has a disinfecting effect and is therefore also particularly suitable for use on any other surfaces that are touched by the studio guest. <i>megaClean</i> comes as a spray in a bottle. It is sprayed onto the surfaces to be cleaned, left to work for some time and then wiped off with a dry and lint-free cloth.
Mirror surfaces Floor plate	The chrome-plated polystyrene surfaces on the door and the mirror plate of the floor are cleaned as follows: Use a damp chamois slightly sprayed with <i>megaClean</i> and wipe the surfaces until they are clean. NEVER USE A DRY CLOTH! Prevent the corners and edges from getting wet.
Plastic surfaces	The large surfaces made of plastic material are cleaned by using a slightly damp cloth (mild washing-up liquid or soap sud). The cleaning agent must never enter the tanning unit!

5.2 Removing and installing the acrylic panes

Removal	To dismantle the panes, remove each right-hand lateral cover profile and turn the panes towards the front. Lift the pane off the guide bars and put it in a safe place. Attention! Do not forget to disconnect the keyboard cable from the rear-wall pane. Unscrew also the selftapping screw in top of the door.
----------------	--



Assembly	After the pane and, if necessary, the tubes have been cleaned, re-insert the pane into the guide bars and close the lateral cover profile.
-----------------	--

5.3 Tubes

Note for T230

As the T230 is operated with electronic starter: After having switched off the tubes wait at least one minute before switching on again. Otherwise the electronic starters may be damaged.

Dismantling

In order to be able to clean the tubes and the facial tanners, carry out the following procedure:

Step	Procedure	Reference
1	Dismantle the lateral panes.	see section 5.2
2	Clean the tubes, or replace them, if necessary.	see paragraph below
3	Install the panes again.	see section 5.2
Note:	Take the tubes out of the lower socket first.	

Cleaning intervals

In order to maintain the tanning power of the system, we recommend that you clean the tubes with warm water and a chamois after approx. 200 hours of operation. Do not use any aggressive cleaning agents or those containing alcohol.

Replacement interval

Tubes and starters must only be replaced by ones of the same type! When installing the tubes, make sure that the lettering is visible, which means that the reflector of the tube is on the rear side.

Always carry out a reset after each tube replacement if your tanning unit is equipped with CPI technology (see section 8.2.2). If you possess an inductive unit, also replace the starters when replacing the tubes. Reset the operating hours counter of the tubes to zero after each tube replacement, see section 8.3.

Inductive tanning units	CPI-equipped units		
	Mode		
Replace starters with each tube replacement!	Eco	Power	Super P.
500 - 600 h	1200 h	1000 h	800 h

5.4 Cooling and exhaust air

Body cooling



The fan control ensures that the fan increases its output gradually to 60% of its rated power. Should the amount of air not meet the individual expectations, the power can be increased via the operating panel. The fan on the ceiling aspirates the air through the lateral slots and blows it off towards the top. For this reason, a minimum cubicle height of 2.40 m must be observed.

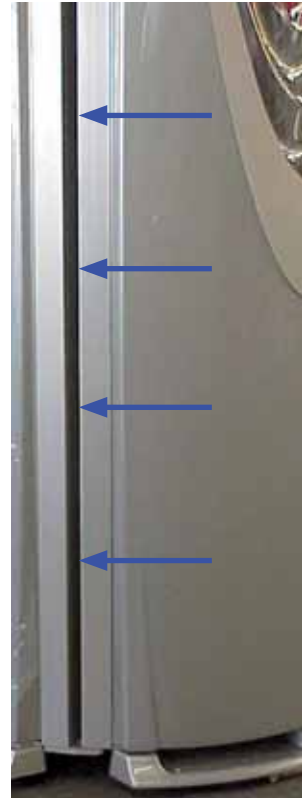

Tube cooling



The air aspirated through the spoilers at the bottom flows upwards, past the tubes, and thus cooling them. The air then enters the tanning tower at the upper edge and is expelled by the fan

aquaCool

Two nozzles spray water within the tanning tower at regular intervals. The nozzles are mounted in the rear wall. The additionally required equipment - compressors, filters - is installed at the lower part of the rear wall, and the water tank is located outside the tanning unit.



Left-hand nozzle



Compressor



Water distribution incl. filters

5.5 Audio system with mp3-sound-box

Components

The rear wall includes the following modules:

- *megaVoice* - the acoustic user guide,
- *mp3-sound-box* for the music option,
- I²C audio switch, and the
- audio amplifier of the musicVibration system

The audio switch is required for I²C bus adaptation, for connection of an external audio signal including volume control, and for connections to the MP3 players. The memory card for the *mp3-sound-box* can be exchanged after opening the pane in the rear wall (see illustration). To do so, remove the pane, the tubes and the covers.

The loudspeakers are located in the rear wall and in the ceiling.

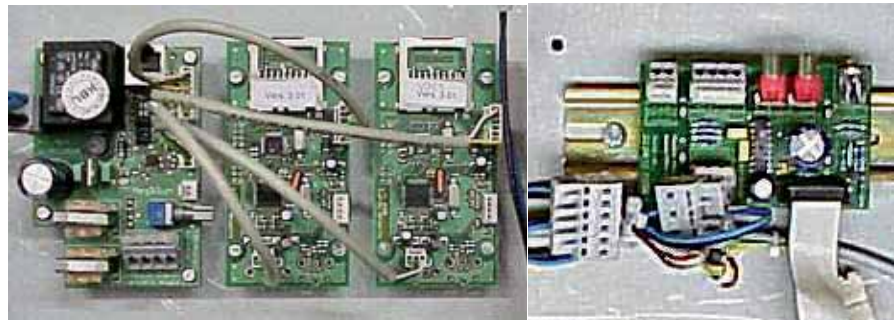

All components of the music system in the rear wall.



To release the memory card, push forwards, then remove.



Insert the new memory card and lock in place

5.6 Replacing the aquaCool nozzles

After 1000 hours of operation, the aquaCool nozzles have to be replaced in order to ensure that aquaCool stays fully operative and efficient. The installation instructions will be enclosed in your spare parts consignment.

6. Technical data

6.1 General data on T230W pureEnergy tanning unit

A sign bearing the following wording must be permanently fixed to the cabin wall near the solarium:

Warning: UV radiation may cause damage to eyes and skin. Ask the operating staff for further information. Wear protective goggles. Certain drugs or cosmetics may increase the sensitivity of the skin (UV type of unit).

Ambient conditions

Installation site	In dry rooms with sufficient ventilation (air supply and exhaust)
Relative air humidity	≤ 70%
Ambient temperature	≤ 30°C
Attention!	The unit must not be operated if the coin-box system or the internal monitoring of the maximum tanning time is defective.

Electrical data

Surface-mounted junction box	≥ (140 mm x 120 mm x 70 mm), with a PG 21 entry	
Mains voltage	400 V / 3N / 50 Hz	
Fuse protection	Automatic circuit breaker, 3-pole, 3 x 25 A, with FI (residual current-operated circuit breaker)	
Wire diameter	5 x 4 mm ² Oilflex	
Internal power socket	For PCs, lamps, or similar. NOT TO BE USED for welding equipment, angle grinders, etc.	
Power consumption T230W pureEnergy T200 Ultra Power	inductive: 12100 W 9800 W	CPI 10500 W 8900 W
52 pieces of tubes: T230W pureEnergy T200 Ultra Power	inductive: megaSun XXL T 230 pureEnergy R Longlife megaSun XXL Ultra Power R 180 W Longlife	CPI: megaSun XXL T 230 pureEnergy R Longlife megaSun XXL Ultra Power R 180 Longlife CPI

Dimensions

Depth x Width x Height	(1205 x 1360 x 2325) mm ³ when closed (1820 x 1360 x 2325) mm ³ with open door
Exhaust-air socket	ø 300 mm (optional)
Exhaust-air hose	ø 300 mm (optional)
Quantity exhaust air	2200 m ³ /h
Mass	420 kg

6.2 Views of the unit

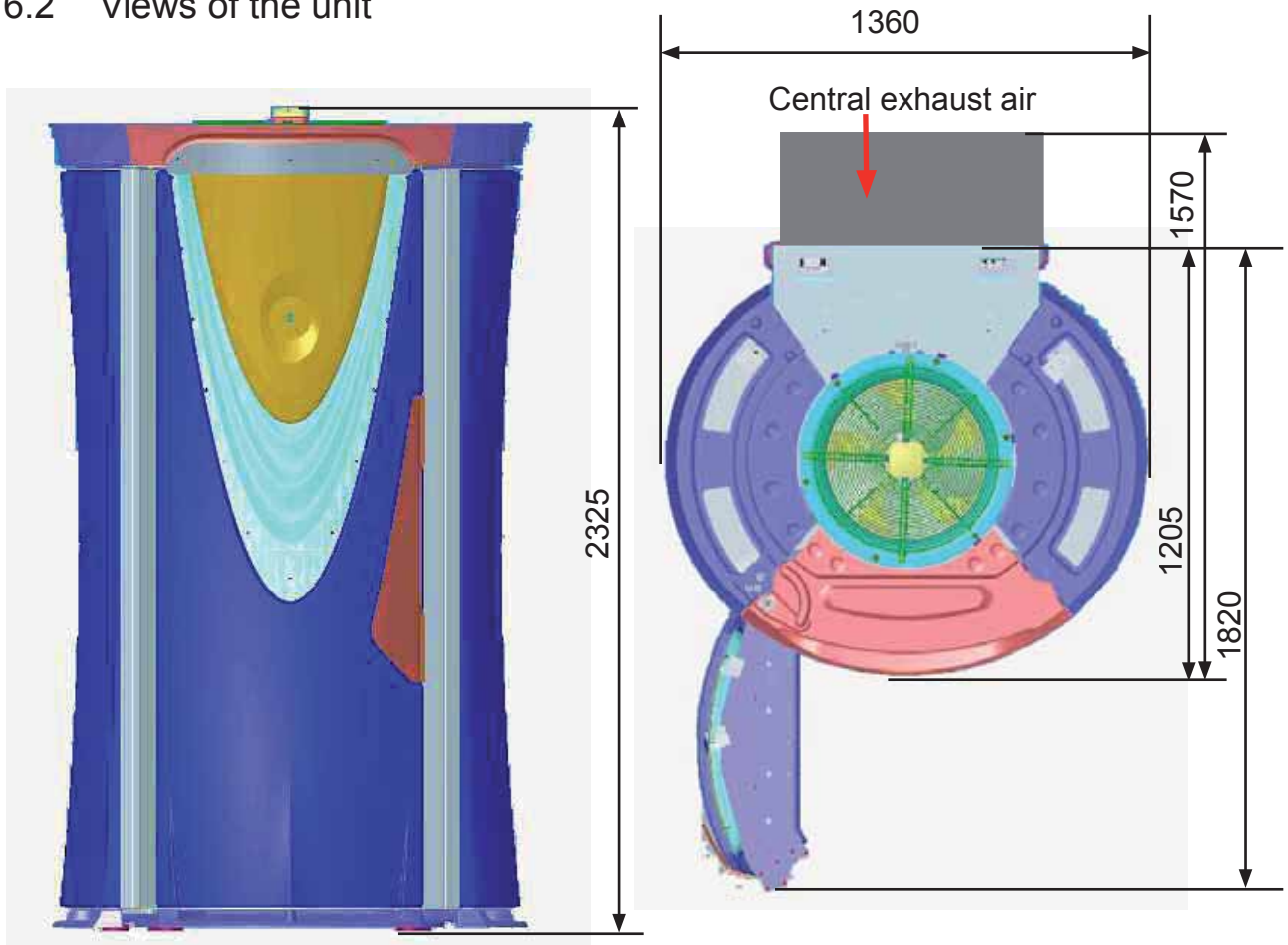

Front view (dimensions in mm)

Top view, with door opened
(dimensions in mm)

7. Wiring diagrams

7.1 Mains voltage

Fuses and residual current-operated circuit breaker

The tanning unit has to be connected to the 400 Volts mains, and fuses are required to protect this connection. For details, please refer to the section “Technical data”.

A residual current-operated circuit breaker (FI protective switch) is absolutely essential. KBL-Solarien AG recommends the following type: KBL 3200 0770 00.

Should any interference occur due to the operation of your tanning unit with the mains, e.g. with ripple-control systems (TRA), consult your power-supply company regarding the installation of corresponding blocking elements (audio frequency suppressor).

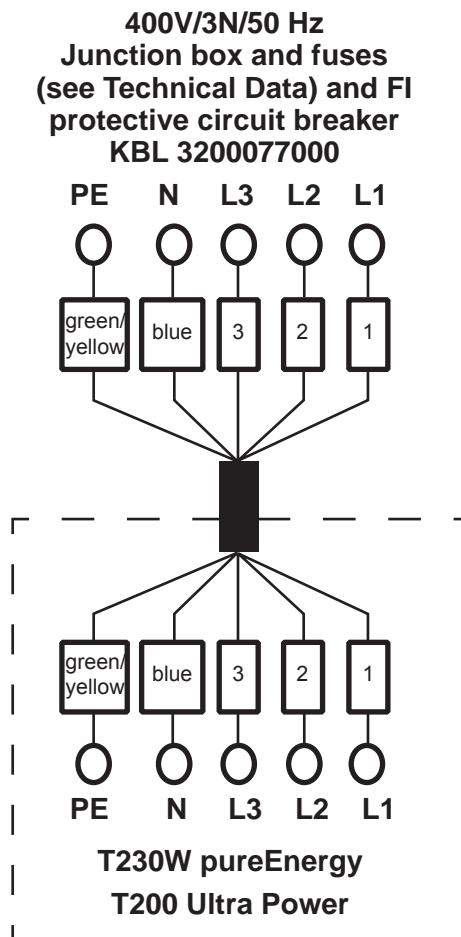

7.2 megaVoice and music

Music

The illustration below shows the equipment (from left to right) covering audio switch, mp3-music, *megaVoice* and audio amplifier for musicVibration.

Components:
Audioswitch,
mp3-Music,
mp3-Voice, and
Audio amplifier
(musicVibration)

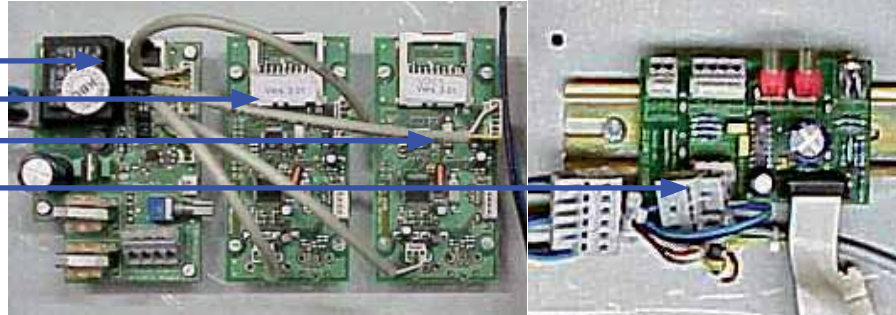

Relay board
Audio components
Processor /4

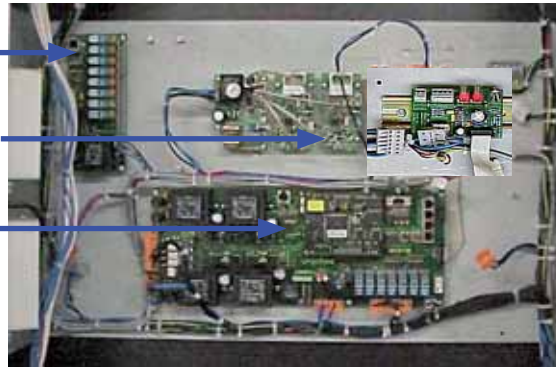

Control board installed on the rear wall, with KBL /4 processor, audio components and relay board for *aquaCool*.

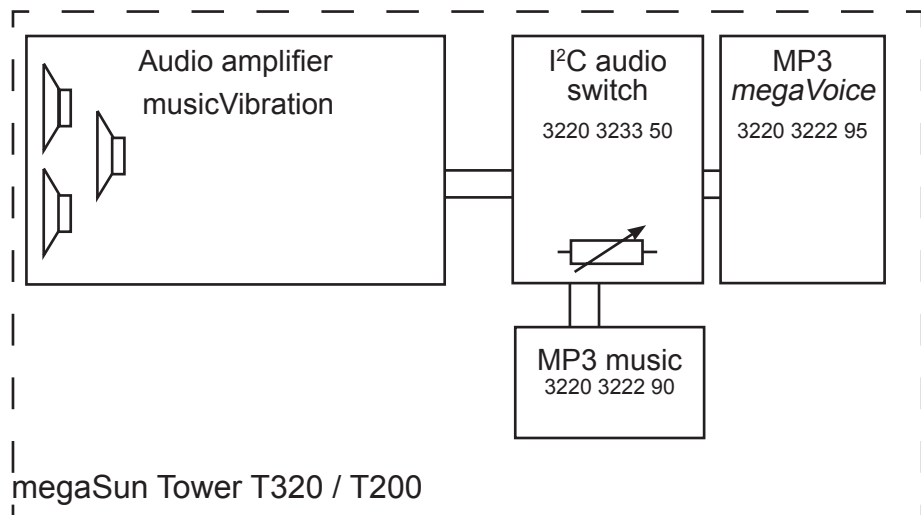

This figure shows how the individual components of the audio system work together.

Principle

7.3 External timer

Timer

The next figure represents the connection principle of a timer. Please always observe the specifications and wiring diagrams applicable for the individual types of timers. The door contact is required when you opt for having the cubicle scented.

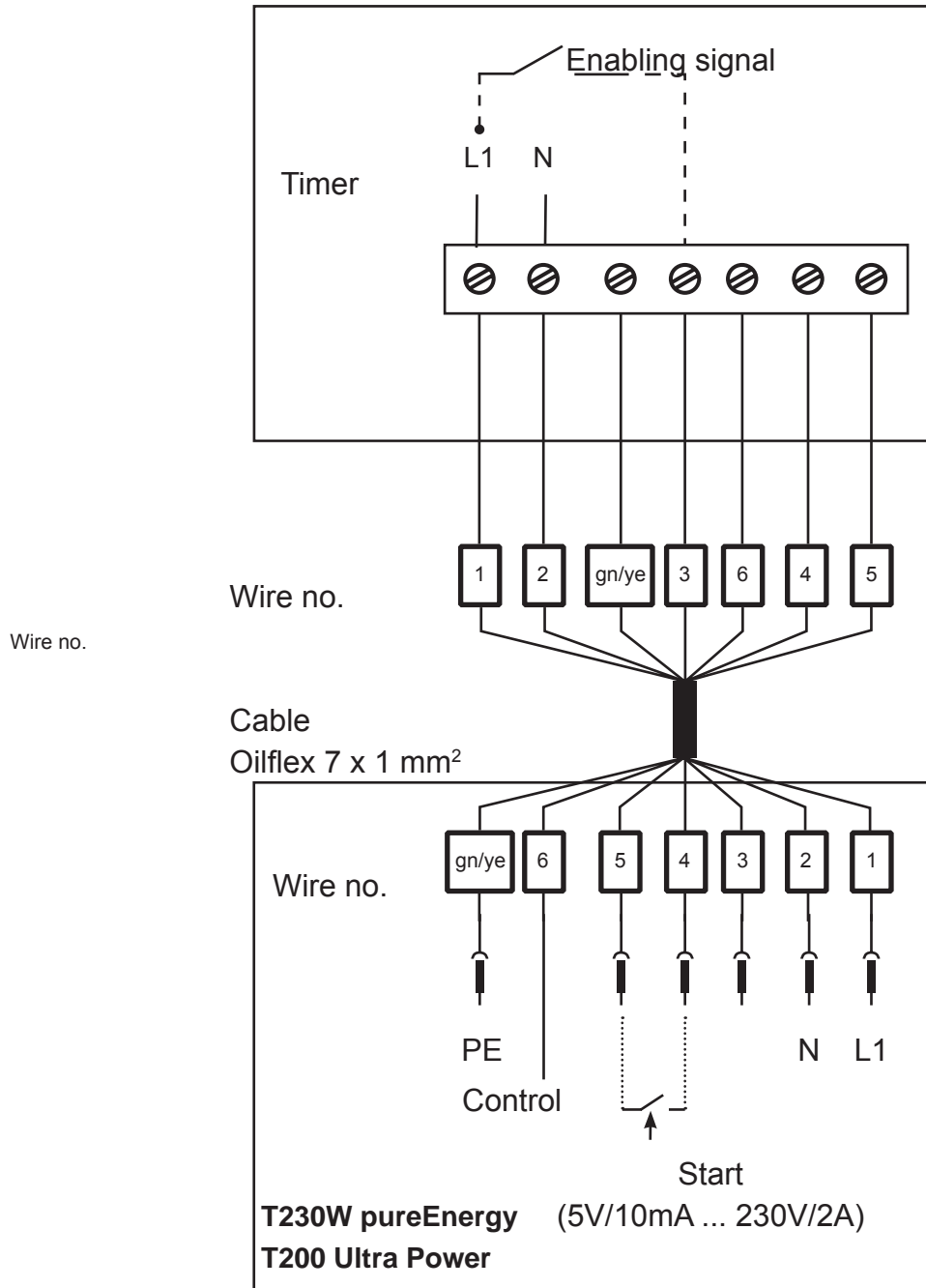

8. Service

8.1 General information and structure

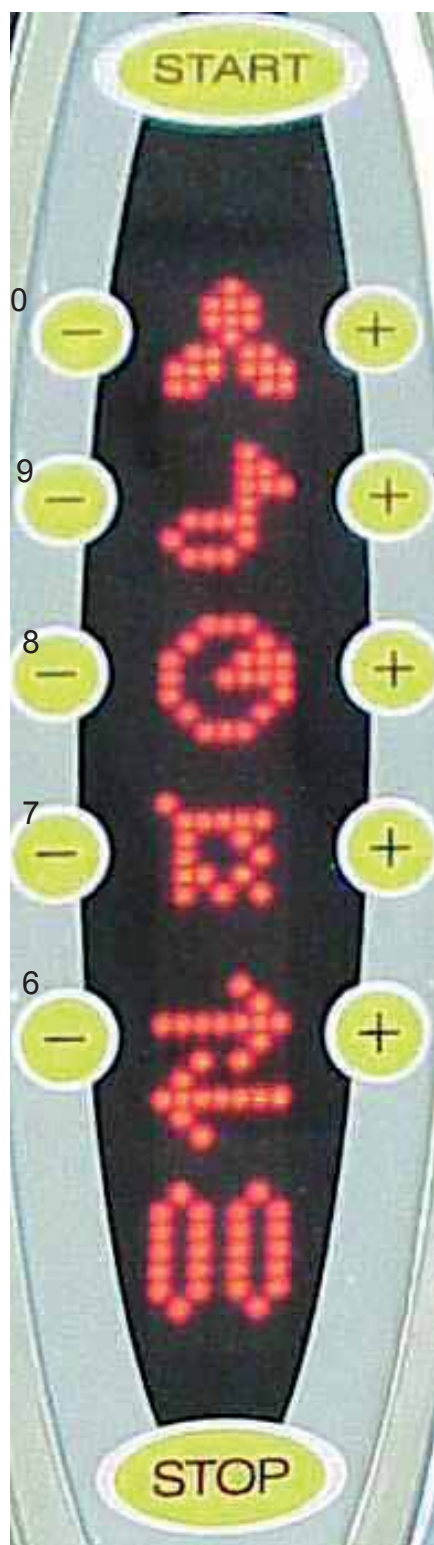

There are two service levels that are both protected by passwords (PINs). In order to access these levels and to trigger any processes there, the “+” and “-” buttons have to be pressed. Therefore, these buttons bear numbers adjacent to them.

In order to get access to the service pages, two prerequisites have to be fulfilled:

- There must not be any error message on the display.
- There must not be any signal coming in from the coin-box system.

In the case of an error message pending, you must first eliminate the error and then reset the message by pressing the “Stop” button.

Service level I:

To access service level I, first enter the sequence 1 6 1, and then enter the PIN 1 1 1 1.

Service level II:

- 2 This level comprises the service pages that must exclusively be used by Technical Service staff.
- Service level II is accessed from level I menu “PIN II” by entering the correct PIN (not 1 1 1 1!). To obtain your PIN, please get in touch with the KBL service staff.

General navigation:

After entering the service level I, use the following touchkeys for navigation:

Key 5	Go forward within the menu
Key 0	Go back within the menu
Stop key	Leave the menu level, or the menu
Start key	Select the menu option, or save the value displayed and changed

8.2 Service level I

The following menus are available on this level:

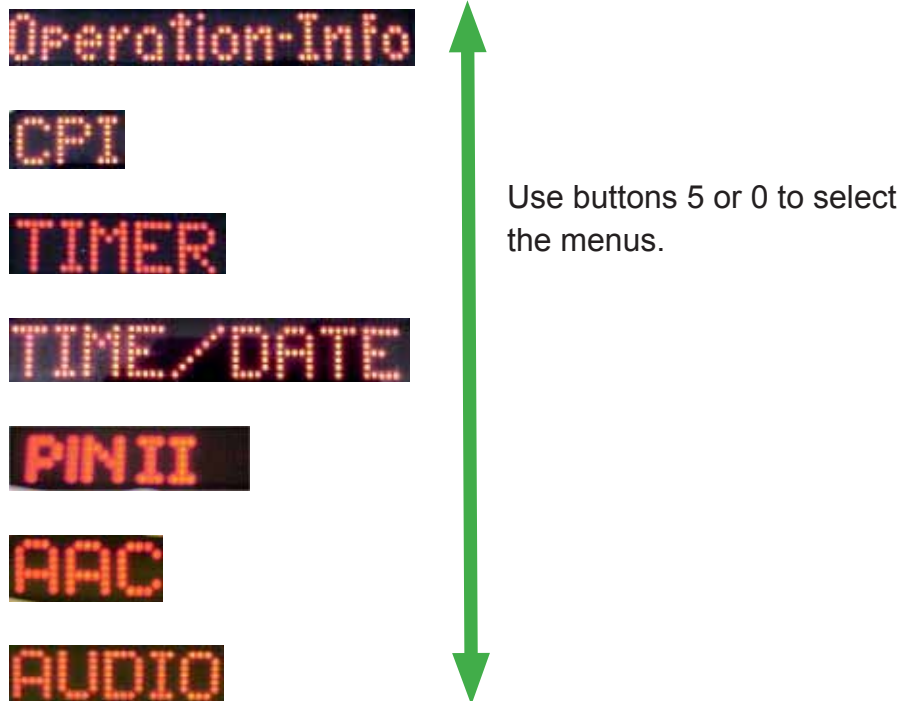

“Operation-Info“ This menu indicates the operating hours of the tanning unit (WORK) and the working hours of the tubes (TUBE).

	START	Display	Selection
Operation-Info	→	00146h WORK	5
	←		
	STOP	00000h TUBE	0

→ The menu is opened by pressing START (here: OPERATION-INFO).

← By touching the STOP button, you return to the superordinate menu (here: OPERATION-INFO).

CPI

This menu provides the available CPI modes for selection and setting. Here you can also reset the CPI system (RESET: press button “1”). By pressing START, you confirm your selection, or you save any changes made.

	START	Setting the CPI mode	Selection	Confirmation
CPI	→	MOD: OKO	4	START
	←	MOD: POWER	9	START
	STOP	MOD: SUPER P.		START

CPI reset	Selection	Confirmation
MOD: POWER	0	
CPI RESET POW	5	1

Timer









This function is used to define two turn-on/turn-off times for each day in order to switch on and off the decorative illumination. If this time setting is not required, it can be deleted by pressing the “1” button. Hours are set by using buttons “2” - “4” and minutes via the buttons “3” - “8”.









		Day of the week: Monday to Sunday	Selection	Confirmation
TIMER	START	MO	0	START
			
	STOP	SU	5	

Turn-on/turn-off time A/BON and A/BOF	h /min	Save
MO --:-- BON	2 3	START
MO --:-- BOF	4 8	START

Time / Date





This menu shows the date and time. Both values can be changed.

		Date display	Selection	
			 5	
	 		 0	
				

Changing the time	Selection	Save
	hrs min 1  3 6  8	
Changing the date	Day	Save
 The day of the week is set automatically.	 1  6	

PIN II

By entering the correct PIN, you proceed to service level II.

		Entry of PIN II, then the "service level II" menu is opened. Please contact the KBL service staff in order to obtain PIN II.
	 	
		

AAC



This menu offers the following submenus:

- AQUA
- CYCLE

As with all of the menus, selection is made by pressing the "0" and "5" buttons.







Aqua

... is a submenu of AAC. Here you can set details regarding the water atomisation:

- AQUA ON / OFF: This function is switched on by pressing the "+" button (4) located above the "OFF" field and switched off by pressing the "-" button (9) below "ON".
- AQ.TIME: The spray intervals are set in the CYCLE



menu, and the spraying time can be adjusted to between 2 and 6 seconds in this AQ.TIME menu. The setting is made by pressing the “+” and “-” buttons above or below the time displays (4, or 9 resp.).

- AQ.CONT: The fill level of the water tank is given in the second submenu. If the level has reached 0 %, this is also indicated after the tanning session. After having changed the canister, this message must be acknowledged (see 8.3 and 8.4).

			Selection	On / Off
			0	4 / 9 
				Acknowledgement see 8.4
			5	Setting 4 / 9 

Cycle

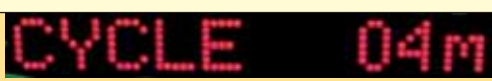
The breaks applicable to the *aqua* function are set between 1 and 5 minutes.
The setting is made by pressing the “+” and “-” buttons above or below the time display.

		Setting	Confirmation
		+ / -	

Audio



This menu comprises the following submenus:

- PRESEL: the menu allows to preselect the music source from Wellness, Pop and / or Studio (external source) as the audio signal. The tanning client may choose the sources in the operator menu.
- WPS: here it is possible to define the actual configuration of the music sources (what is implemented in the Tower?). W: , P: means Wellness and Pop are active, S: external music is not active (next page).
- VOL. HOT: the volume of the music, or the guiding voice, with the fan working

- VOL. COOL: the volume of the music, or the guiding voice, while the fan is not working.
- NONSTOP: If the signal is set to ON, the audio signal is played continuously. Otherwise, the music stops when the tanning session ends.
- CH: The channel selection can be switched over from the usual setting (channel and volume) to BCD selection. Four different audio sources can be selected (volume in the audio amplifier).

Selection from the menus is made via the “0” and “5” buttons, functions are switched on or off by pressing “+” (ON) or “-” (OFF), and values are increased or decreased by touching “+” / “-” right or left of the number.

			On / Off	Confirmation
AUDIO	START	PRESEL. W	+ / -	START
	← →	W.P.S'	+ / -	
	STOP	VOL.HOT 88%	Setting + / -	In steps of 2%
		VOL.COOL 58%	Setting + / -	In steps of 2%
		NONSTOP ON	On / Off + / -	
		CH BCD	5	C START on
		CH PULS	0	

8.3 Service level II

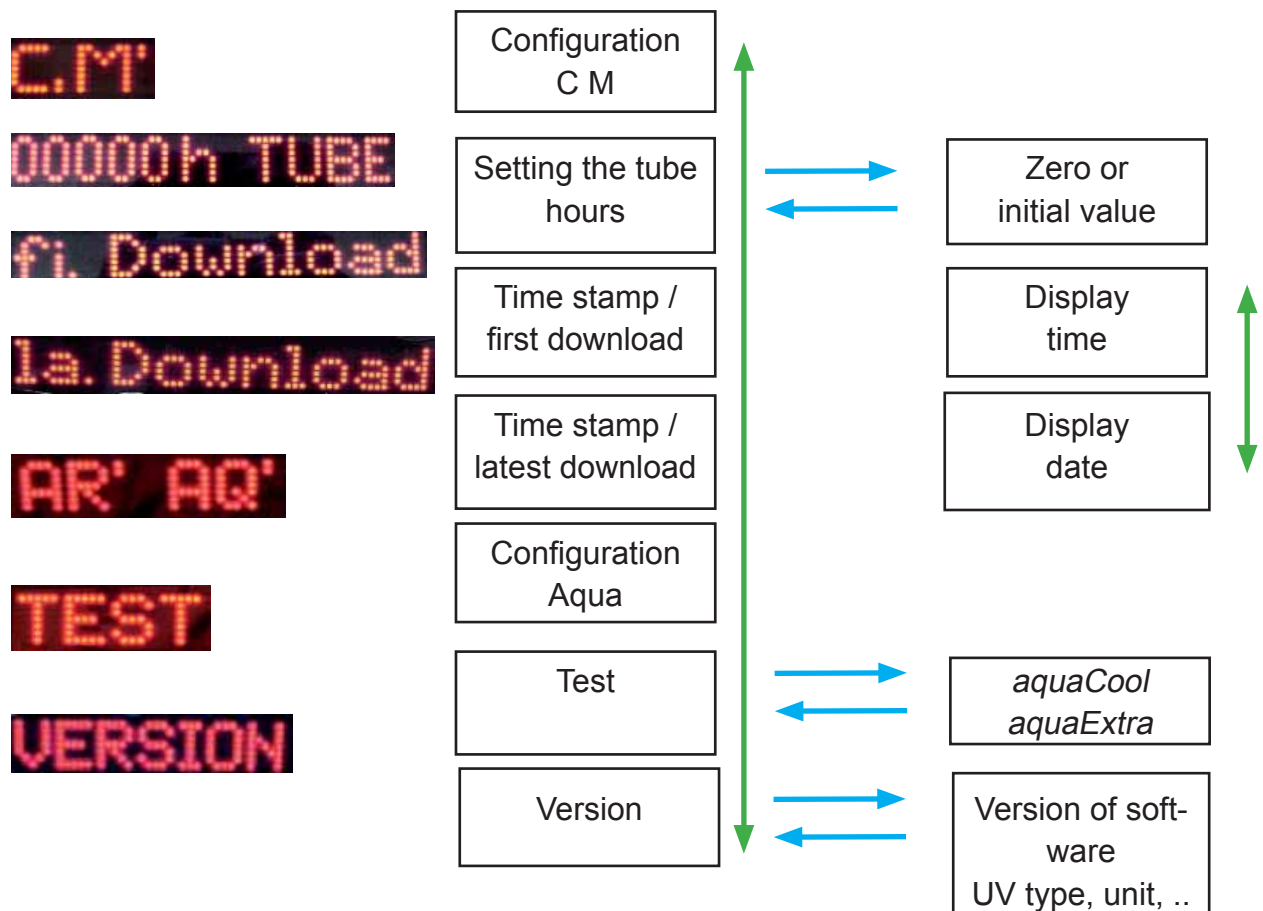

Configuration



In this menu, functions are activated or deactivated. This feature is useful in case a function is missing or temporarily unavailable (shielding).

C Audio channel
M Volume (music)

The setting can be changed by pressing the “+” or “-” buttons above and below the symbol. If the letter is followed by a short vertical stroke (actually a colon) at the bottom, the corresponding function is not available.

Example:

C. channel selection available, M: music impossible.

easyCare

Menus for easyCare functions see Manual easyCare“

Tube hours

In this menu, you can set the tube hours in steps of 5 hours. After a tube replacement, this display must be reset to zero. **Attention! Make sure that you carry out a reset after each tube replacement.**

	Setting the tube hours	Change	Save
START	00000h TUBE	1	START
STOP		6	

Time stamp

Here the system files time stamps of when the software was loaded for the first time (first download) and when the latest download took place (last download).

			Selection
f1. Download	START	13:10	5
First Download			
	STOP	22.01.03	0
la. Download	START	09:34	5
Last Download			
	STOP	29.01.03	0

aquaCool



The function can be activated (AQ.) or deactivated (AQ'). The setting can be changed via the "+" or "-" buttons on the right-hand or left-hand side of the symbol.

All changes made are taken over by the system when the START button is pressed.

Test

The two functions *aquaCool* and *aquaExtra* can also be tested if no tanning program has been selected.

After choosing the function, press the “1” button in order to start the functional test.

aquaExtra is switched on or off by means of the “4” and “9” buttons. This test has a 5-minute cycle time which is necessary to check the quality of the spraying process.

		Submenus		On
TEST	START	AQUATEST		1
	← →	AQUA EXTR.OF	4	
	STOP	AQUA EXTR.ON	9	

Version

The version of the software loaded is displayed, from version 4.8 for tanning units without easyCare (here 5.3) or with easyCare (here 1.8). The display is similar to the one shown when the system is started.

			Selection
VERSION	START	Display 13	5
Type of tube	STOP	XXL SUPER P.	
System family		KBL4 TW 2.0	
Tanning system		T230	0

8.4 Replacing the *aquaCool* tank

The water tank is located outside the tanning unit. Ensure scrupulous cleanliness when changing the tanks.

Step	Procedure	Reference
1	Check the fill level in the water container on a regular basis. If the reservoir is depleted, replace the tank.	
4	Screw the lid including the hoses off the tank and replace the empty tank with a full one. Screw the lid on again. When replacing the tank, place the two hoses into a plastic bag so that they remain clean. Exclusively use the special water “aquacool” supplied by KBL. Otherwise, infections may spread and the nozzles may clog.	
6	Acknowledge the message on service level I by selecting the displays shown on the right-hand side and by pressing the “1” button.	

8.5 Colour codes used for the water hoses

Colour codes The hoses are marked by coloured dots:

- Blue compressed air for *aquaCool*
- Red backflow *aquaCool*
- Green supply *aquaCool*



8.6 Error messages

Error messages “Exhaust air“	<p>This error message is shown on the display and can be acknowledged by pressing the STOP button.</p> <p>Before doing so, make sure that the cause of the error has been eliminated by service staff.</p> <p>Reasons for this message may be the following:</p> <ul style="list-style-type: none">— temperature within the unit too high, or— exhaust-air blower defective, or— insufficient cooling of the unit
Error messages “End of tanning session“	<p>After 30 minutes of uninterrupted tanning, this message is shown on the display.</p> <p>It is acknowledged by switching off the coin-box system.</p>
BUS error	<p>Data line of the I²C bus is faulty:</p> <ul style="list-style-type: none">— 230 V voltage supply is missing at the MP3 player or the audio switch— Bus connector incorrectly plugged into the MP3 player
E01BUS:ABL	<p>This error message appears when the control board does not communicate with the speed control.</p> <p>Cause: I²C speed control faulty or not connected.</p>
E02:BUS:TMP	<p>Cause: I²C temperature sensor faulty or not connected.</p> <p>Acknowledgement: the Start button can be used; in this case, the exhaust-air fan operates at maximum power during the temperature control.</p>
E04:BUS:VOIC	<p>Cause: no data communication between control board and MP3 player Voice.</p> <p>Acknowledgement: the Start button can be used. The control will then work as if <i>megaVoice</i> was not installed.</p> <p>Reasons:</p> <ul style="list-style-type: none">— missing solder bridges at the <i>megaVoice</i> MP3 player,— SD card cannot be read – formatting, wrongly plugged in— plug at the MP3 interface or the IC audio switch incorrectly positioned
E05BUS:REL	<p>Configuration error if an 8-fold I²C relay board and a 2-fold I²C relay board are connected at the same time.</p>

9. Tanning instructions

9.1 General tanning instructions

1	<p>The various skin types can tolerate exposure to sun and the duration of tanning sessions to different extents. Observe the skin-type table and the respective tanning program (see pages 56 ff.).</p> <p>Once you have achieved your final tan, further tanning can only be reached by considerably exceeding the admissible tanning times. This must be avoided at all costs!</p>
2	<p>UV radiation emitted by the sun or by UV devices may cause damage to skin or eyes. These biological effects depend on both the quality and the quantity of the radiation as well as on the individual sensitivity of the skin.</p>
3	<p>The skin may develop sunburn after excessive exposure. Excessively frequent exposure to UV radiation emitted by the sun or by UV devices may lead to premature ageing of the skin and to an increased risk of developing skin cancer.</p>
4	<p>The unprotected eye may develop surface inflammation, and in some cases, e.g. after a cataract operation, excessive exposure to UV radiation may damage the retina. After numerous repeated tanning sessions, eye cataracts may form.</p>
5	<p>Special caution is required in case of pronounced individual sensitivity to UV radiation and in cases where certain cosmetics or medicine are involved.</p>
6	<p>It cannot be generally assumed that exposure to UV radiation in tanning systems reduces the risk of suffering sunburn in any individual case.</p>
7	<p>The tanning unit must not be operated if the timer is defective.</p>
8	<p>The following safety precautions are required:</p> <ul style="list-style-type: none"> — Always use the goggles provided. — Remove any cosmetics in advance of exposure and do not use any type of sunscreen. — Do not undergo exposure when taking any medicine that increases the sensitivity of the skin to UV radiation. If in doubt, a doctor must be consulted for advice. — There must be an interval of at least 48 hours between the initial two tanning sessions; do not go sunbathing on the same day. — Follow the recommendations regarding durations of exposure and intervals (see 9.1 ff). — Seek medical advice if persistent lumps or sores develop on your skin or if pigmented moles start altering.

9	<p>The following groups of persons must not use the tanning unit:</p> <ul style="list-style-type: none"> — Children — Persons with heart pacemakers — Persons that suffer sunburn without any tanning effect when exposed to the sun — Persons suffering from sunburn — Persons currently suffering, or having suffered, from skin cancer, or that have a corresponding predisposition
10	<p>Tanning units of UV type 4: Attention – Do not use without consulting a doctor in advance.</p>

9.2 megaSun T230W

Tanning session	Skin type II	Skin type III	Skin type IV
	Time in min		
1	2	2	2
2	2	2	2
3	2	3	3
4	3	3	3
5	3	3	4
6	3	4	5
7	3	4	5
8	3	5	6
9	4	5	6
10	4	6	7
11	4	6	8
12	5	6	8

The interval between two tanning sessions must be at least 48 hours.

9.3 megaSun T200

Tanning session	Time in min					
	Skin type II		Skin type III		Skin type IV	
	ind.	CPI	ind.	CPI	ind.	CPI
1		4		4		4
2		5		5		5
3		5		6		6
4		6		7		8
5		6		8		9
6		7		9		11
7		7		10		12
8		8		10		13
9		8		11		14
10		9		12		15
11		10		13		17
12		10		14		18

The interval between two tanning sessions must be at least 48 hours.





10. Assembly

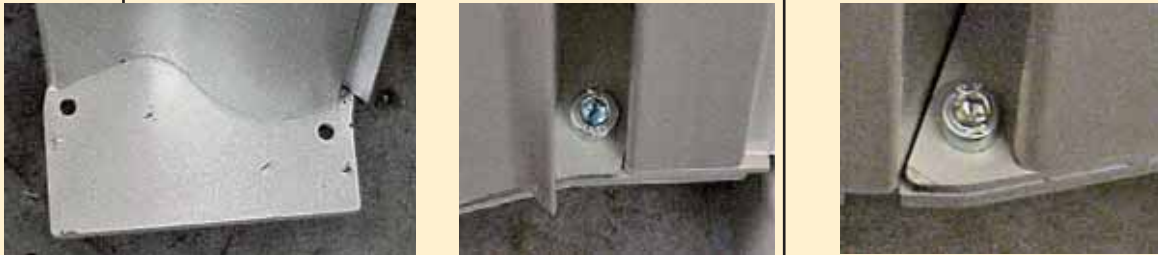

Tools A standard tool set, including keys for Allen screws (e.g. 3.5 mm), a spirit level and a step ladder.

Cubicle height The cubicle must be at least 2.40 m high.

Assistance For unpacking, three assistants are required, and one to two other people are needed for installation.

10.1 Mounting of the Tower

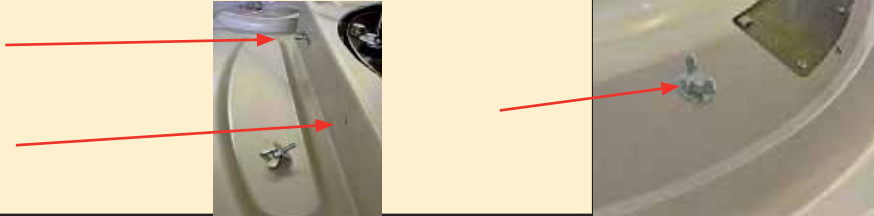
Step	Procedure	Reference
1	<p>Install the rear wall so that it is level.</p> <p>The distance between the base plate and the floor is approx. 70 mm.</p>	
2	<p>Screw the left-hand side part to the rear wall at the top and at the bottom and make sure it is level.</p>	
3	<p>Screw the right-hand side part to the rear wall at the top and at the bottom (Allen screws) and make sure that it is level.</p>	 <p>Right-hand upper part</p>
4	<p>Hinge the door at the bottom of the left-hand side part and use three screws to screw the door to it at the top. Then make sure it is level.</p>	
5	<p>Place the ceiling part including the blower on top of it and screw with 6 M8 SW 13 nuts.</p>	

6	<p>Guide the cables from the door and the lateral (side) parts through the upper platband and fix it with 4 wing bolts (2 from the front and one each on the right-hand and left-hand side).</p>	
7	<p>Connect all cables at the top. DO NOT MIX THEM UP!</p>	
8	Put the mirror floor-plate in place.	
9	Connect the timer cable.	
10	Connect the mains cable to the fuse box.	
11	<p>Switch on the unit and start a test run.</p> <p>Note: As the T230 is operated with electronic starter: After having switched off the tubes wait at least one minute before switching on again. Otherwise the electronic starters may be damaged.</p>	

10.2 Assembling of the Central Exhaust Air

Installation variants

The central exhaust-air unit can be mounted in 5 different ways:

The hose connection can be:

- at the top or at the bottom,
- on the right-hand or on the left-hand side, or
- on the backside

at the top		
at the bottom		
on the right side or on the left side		



Mounting instructions





Arrange all parts you need for the assembling as you can see in to facilitate mounting, arrange the parts in the way you need them and as the pictures show. Use snap rings or Loctite for securing where appropriate.





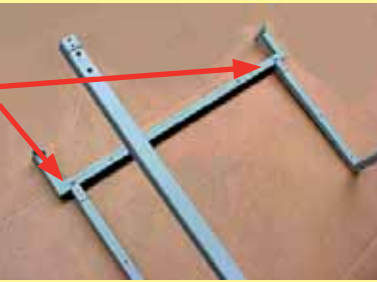
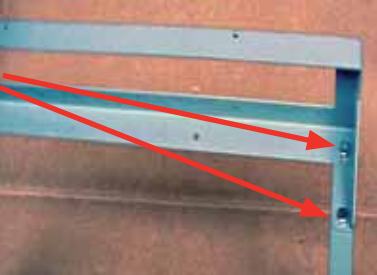

Fan mounting

The fan mounting frame is always screwed to the inside of the exhaust frame bar (see respective picture on the right).

Space requirements

The space required for the Tower grows to 1570 mm in the depth dimension (when door is closed).

1	Put lower support joint on the floor.	
2	Screw the right and left lateral joints to the lower support joint, fan mounted laterally (on the right or on the left side). Hexagon screws M6 x 12 (3120077000) and retainers (3120533000).	
3	Mount joint on the backside at the top, 2 M6 hexagon screws each (on the right and on the left). Hexagon screws M6 x 12 (3120077000) and retainers (3120533000)..	
4	Screw fan mounting to a side part (right or left) (4 Hexagon screws M6 x 12 (3120077000) and retainers (3120533000).)	
5	Mount fan using 4 M6 nuts and retainers.	
6	Mount black bottom plate using 4 Hexagon screws M6 x 12 (3120077000) and retainers (3120533000).	
7	Mount backplate (8 M6 hexagon screws).	
8	Insert lateral plates behind the joint and mount them (on the right-hand and on the left-hand side) using 5 self-tapping screws 4,2 x 13 (3120568000).	

9	<p>Put cover on top and mount it using 6 self-tapping screws.</p> <p>Note! All pre-punched cutouts that are not required have to be masked, i.e. leave open only the one through which the fan blows.</p>	
10	<p>Put on the air-outlet conduit and mount it. (Here the exhaust is at the top). 4 pcs hexagon screws M6 x 16 and 4 pcs. nuts M6 (3120534500) and retainers (3120533000).</p> <p>Guide the fan cable into the interior at this time.</p>	
11	<p>Screw fan to the tower. 4 pcs. hexagon screws M6 x 45 (3120081500) and retainers (3120533000)</p> 	<p>bottom</p>  <p>Screws 3,9 x 12</p>
12	<p>Put rim on top and mount it. Insert the protection grid in the front part above the door. Protection grid:</p> 	<p>Protection grid in the rim above the door.</p> 
13	<p>Mount the cover plate: 12 pcs. lens head screws 4,2 x 9,5 (3120234000) and nuts 3,9 (3120539000), put cover plate on top and fixe it using 12 pcs. hexagon screws 4x20 (3120072000) and washers 4,3x12x1,25 (3120509500).</p> <p>Mount hose connection 4 pcs. hexagon screws M6x16 (3120078000) and retainers</p>	

14	Fix exhaust-air hose..	
15	Wire the fan (plug connection in rear wall).	

11. Index

A		G	
AAC	25	General tanning instructions.....	33
Acrylic panes		H	
Cleaning	13	Handholds	
aquaCool function		Cleaning	13
Function	10	I	
Nozzles.....	15	Interior lighting	12
aquaCool tank		L	
Replacing	31	Lighting of the unit	12
aqua function	25	M	
aroma / aqua	29	Mains connection	19
Audio	26	Mains voltage	19
Service level I.....	26	Maintenance plan.....	5
Audio system		megaVoice	10
Components.....	16	Music	20
B		Mirror surfaces	
Body cooling.....	15	Cleaning	13
Body fan.....	9	mp3-sound-box.....	16
C		N	
Channel selection.....	9	Navigation	
Cleaning	13	General.....	22
Colour codes		O	
Hoses.....	31	Operating panel	7
Configuration	28	Operating panel and display.....	7
Service level II	28	Operation	6
CPI		Operation/Info.....	23
Service level I.....	24	Optional functions/equipment.....	6
CPI reset.....	24	Options.....	6
Cubicle height.....	35	P	
Cycle		PiN II.....	25
Service level I.....	26	Plastic surfaces	
D		Cleaning	13
Dimensions.....	18		
Dismantling the acrylic panes.....	13		
Door handles			
Cleaning	13		
Door lighting	12		
E			
Electrical connection.....	17		
Error messages	32		
External timer	21		

R		V	
Refilling	31	Version	30
aroma	31	Service level II	30
Replacement interval	14	Views of the unit	18
Replacing		Volume	9
Water	31	W	
Run time	10	Wiring diagram	
S		External timer	21
Service	22	Mains voltage	19
Service level I	23		
Time / Date	25		
Service level II	28		
aquaCool	29		
Start	9		
Stop	9		
T			
Tanning instructions	33, 35		
Tanning program			
T180 Ultra Power	35		
T230 pureEnergy	34		
Technical data	17, 38		
Ambient conditions	17		
Dimensions	18		
Electrical values	17		
Termination of tanning session	11		
Test	30		
Service level II	30		
Timer	24		
Service level I	24		
Timer connection	21		
Time / Date	25		
Time stamp	29		
Tools	35		
Tubes	14		
Cleaning	14		
Dismantling	14		
Replacement interval	14		
Tube cooling	15		

